

ITS-MSM-1515

Description

An electromagnet is a core of magnetic material (such as iron) surrounded by a coil of wire through which an electric current is passed to magnetize the core.

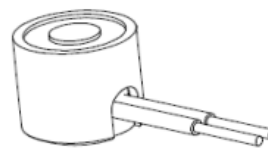

Weight: 20 g

Haltekraft: 20 N

Anzugsplattendicke: 2 mm

Coil Data

Duty (%)	100	-	-	-
Power Drain (Watt)	1,4	-	-	-
Max. Duty (Seconds)	∞	-	-	-

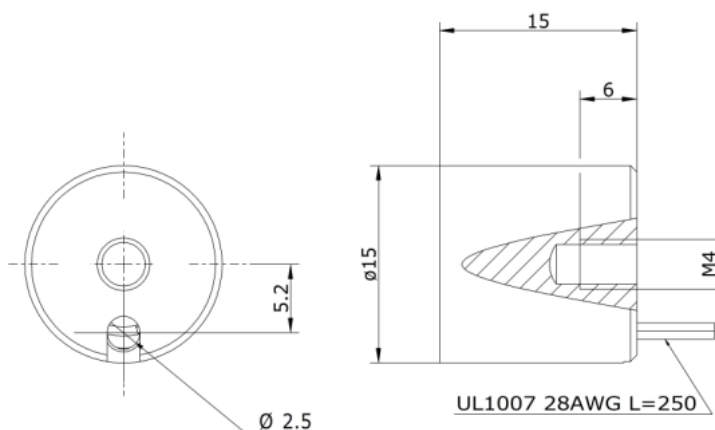

Solenoid Layout

Voltage:

12 VDC (standard)

24 VDC (standard)

other voltages on request

Special development

Sie wollen diesen Standardmagneten abändern (z. B. Abmessungen, Kräfte, usw ...) dann senden Sie uns einfach dieses Formular: [Checkliste \(PDF, 390 kB\)](#)